

INSTRUCTIONS FOR USE

LIGHT CALIPER

59

WATER-RESISTANT

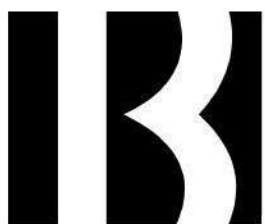
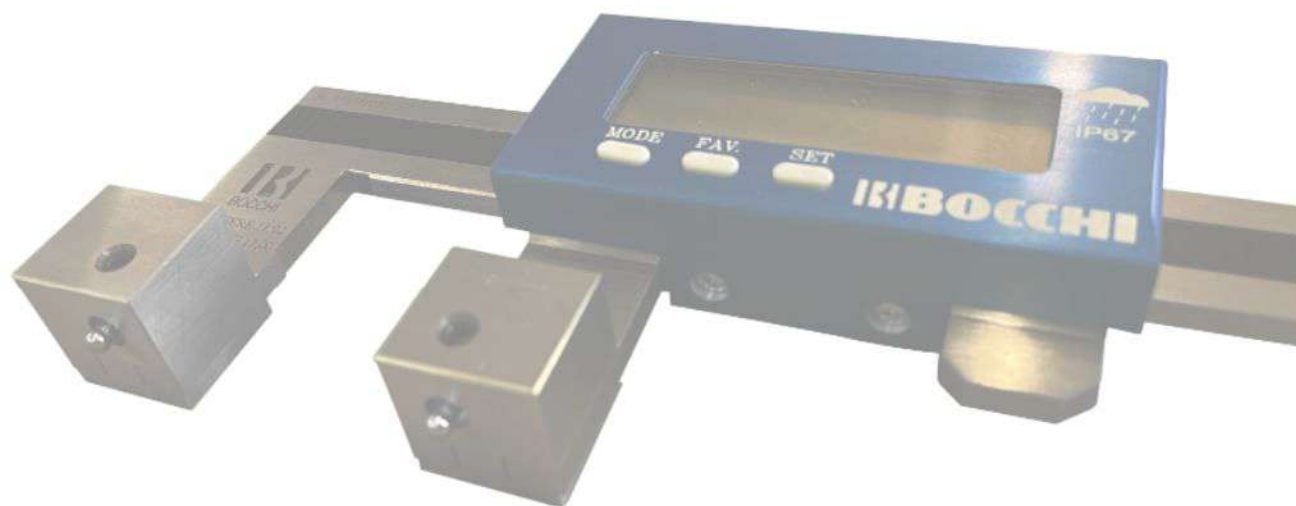

BOCCHI

BOCCHI S.R.L.

Via Palazzolo, 41

25037 Pontoglio (BS) - Italy

Tel. +39 030 737252

Fax +39 030 7376742

info@bocchicontrol.it

www.bocchicontrol.it



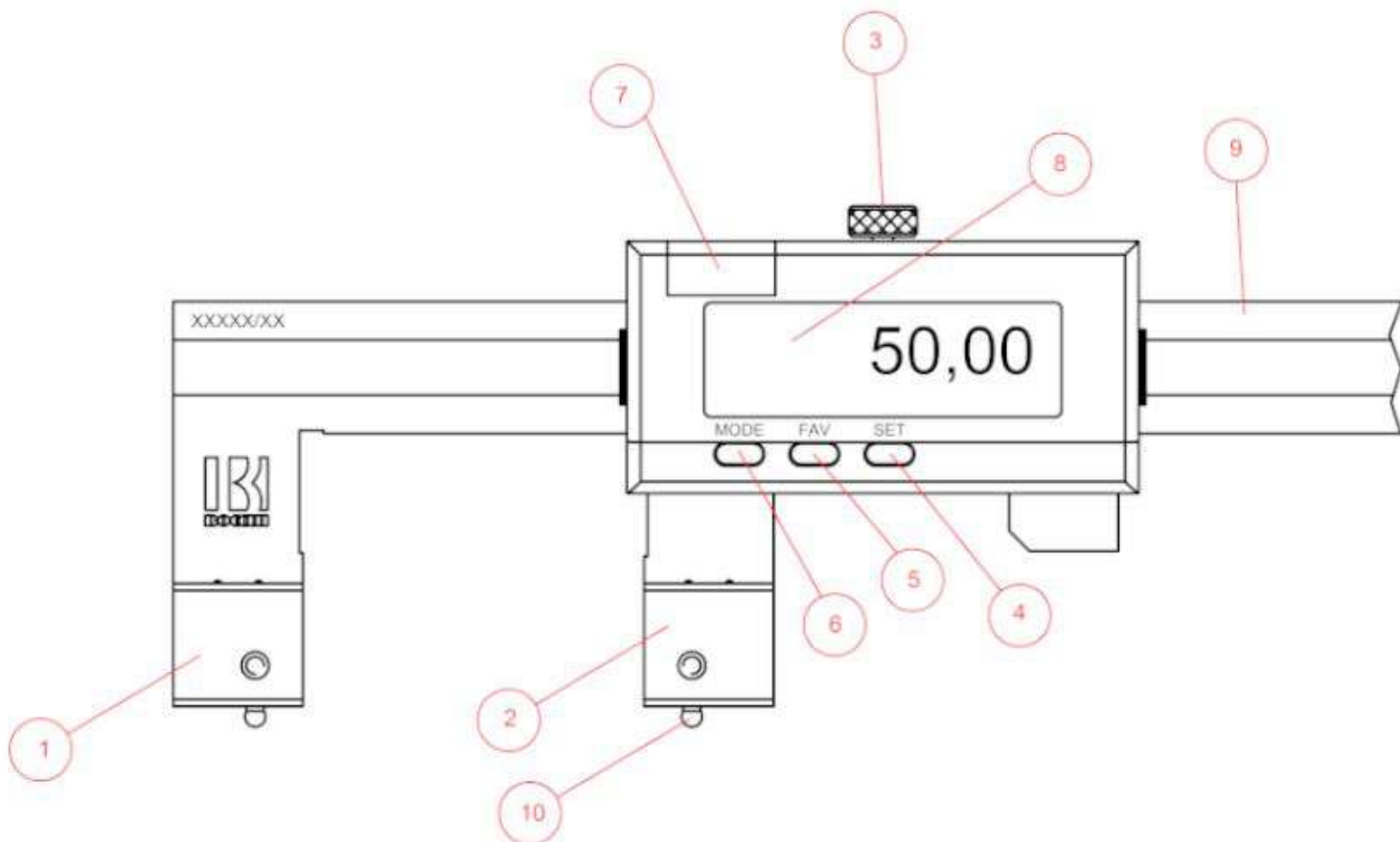

1. Left measurement jaw
2. Right measurement jaw
3. Right cursor clamp knob
4. SET button
5. Favourites button
6. Mode button
7. Battery cover and data Output
8. Display
9. Main beam
10. Spherical Inserts



1. Measurement unit (mm/INCH)
2. + / - indicator
3. Low battery
4. Active tolerance mode
5. Button locking
6. Preset mode
7. Multiplication factor
8. 6 1/2 digits display
9. Freeze measurement value
10. Bluetooth® connection
11. Send data
12. MIN / MAX / DELTA mode
13. Internal/external measurement indicator
14. Active reference indicator
15. Tolerance indicator

3.1 Automatic references

The instrument has the ability to switch automatically between its two references.

This allows using the caliper for both internal and external measuring without going through the menu to change the reference.

Steps :

On Ref 1

- Introduce a measurement standard as preset, measure this standard and do a preset recall
- Or set the zero at closed jaws position

On Ref 2

- Measure the internal measurement probes gap (with a caliper, probes included) and introduce it as preset value
- Do a preset recall at closed jaws position

Set AREF

It is now possible to measure in REF1 when closing the jaws or in REF2 when opening the jaws.

4. Advanced functions

Prolonged pressure (>2s) on **MODE** gives access to the advanced functions.

Then, each short press on **MODE** accesses the required function :

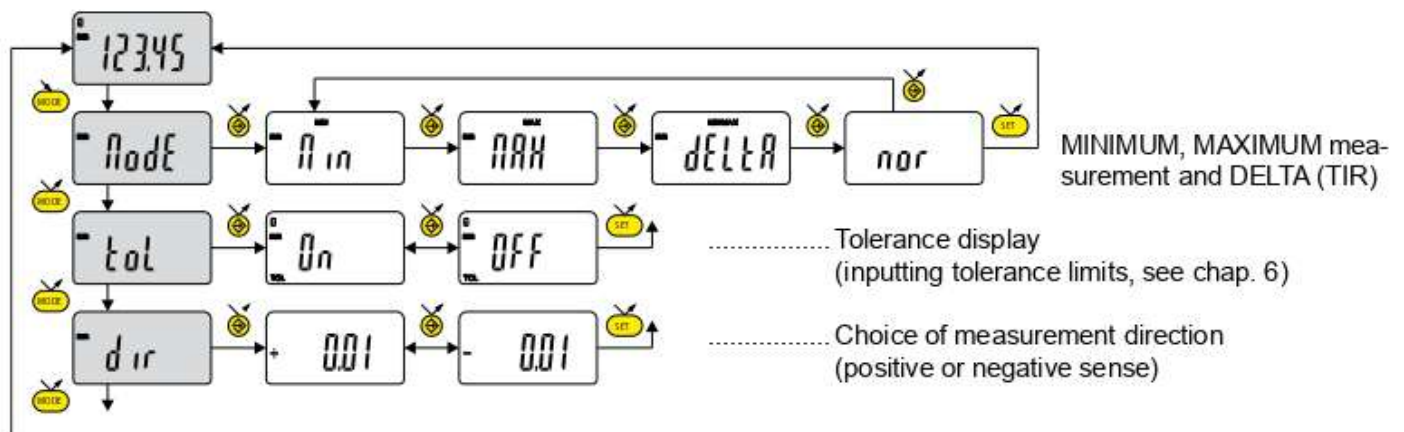

5.2 Bluetooth® specification

Radio frequency	2.4Ghz
Robustness	FHSS
Latency (from not connected state to send data)	<6ms
Range	Open space : up to 15m Industrial environment : 1-5m
Autonomy with CR2477	Continuous : up to 8 months (Always connected with 4 values /sec) Saver : up to 21 months (The instrument sends value only when the position has changed) Blind/Push : up to 24 months (Value is sent from the instrument (button) or requested from the computer)

Other specifications on the manufacturer's website

6. Insert tolerance limits

In order to introduce or modify the tolerance limits, it is necessary to select t_{ol} → t_n , followed by a short press on **MODE**

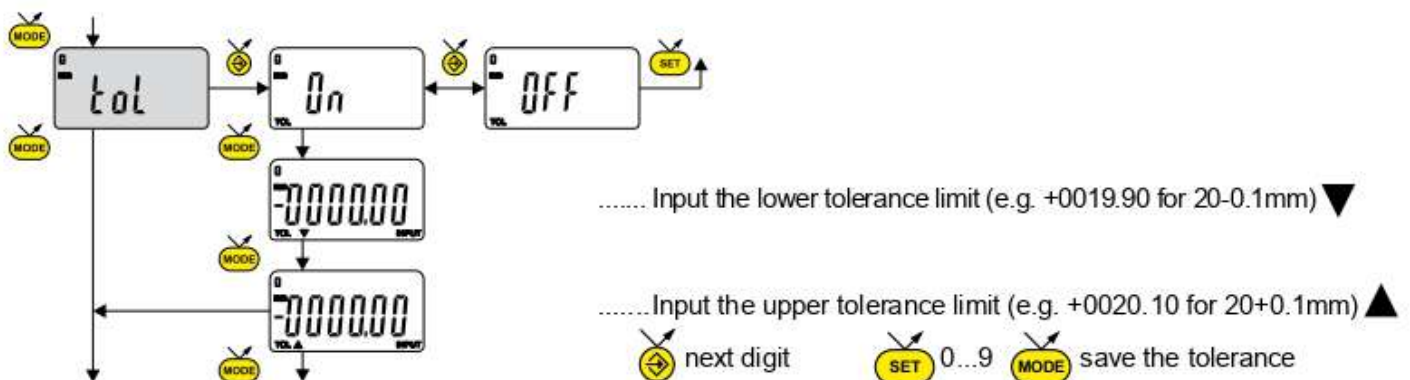

Note :



- In case of measuring internal ratings, you can cross the indicators by reversing the order of entering the tolerance intervals (upper interval < lower interval)
- It is possible to introduce different tolerance limits on REF1 and REF2.
- It is also possible to display the tolerance limits when the instrument is working in MIN, MAX or DELTA (TIR) mode

7. Favourite key

The «favourite» key gives direct access to a predefined function, and can be configured according to the needs of the user.

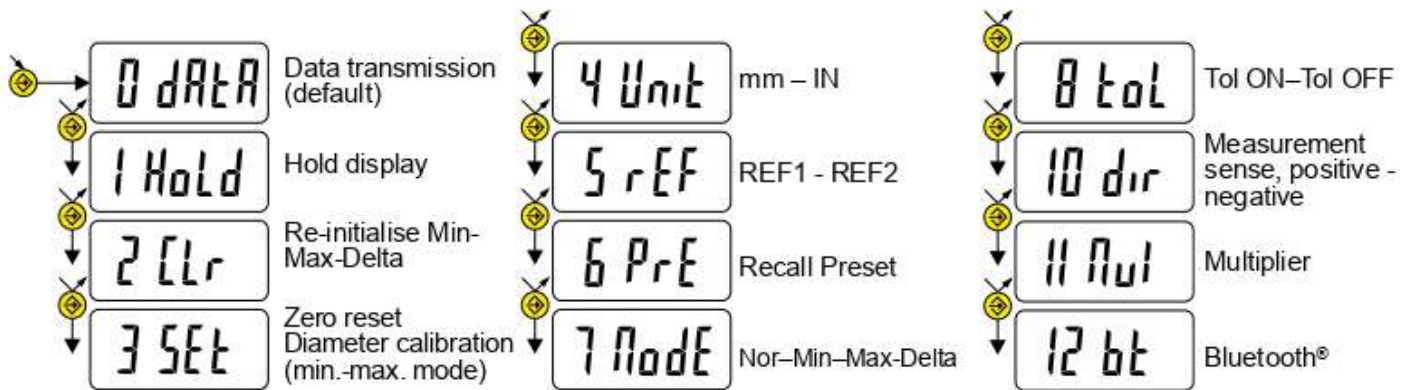
In order to assign a function to the «favourite» key, give a prolonged press on  and then select the required function :



Validation of selection: By a prolonged press on , or a press on  or 

Note: a function can also be assigned via RS232 using the command <FCT + Function No.> / example: Change of Unit = <FCT4>

8. Adjustment of the measuring system

Certain applications need to adjust the instrument to the MIN (or MAX) measured value. In this case, proceed as follows :

8.1 Adjustment of the instrument

- Enter a Preset value corresponding to the actual size of the standard (see chap. 3)
- Select the MIN mode (or MAX, depending on the application) (see chap. 4)
- Make a standard measurement (going through the turnaround point)
- Adjust the instrument by selecting the SEt mode and pressing on the button  (see chap. 3)
- The instrument is adjusted and ready to measure.

8.2 Measure

- Make the measurements. The digital display stores and displays the MIN (or MAX) measured value.
- Before each new measurement, reset the measured value by a short press on 

9. Extinction

The instrument goes automatically into stand-by if not used for 20 minutes, unless Auto OFF mode has been turned off (see Chap. 4, advanced functions)

Stand-by mode can be forced by a prolonged press (> 2 sec) on 

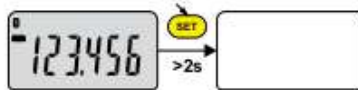

In stand-by mode, the value of the origin is retained by the sensor (SIS mode), and the instrument automatically restarts with any movement of the measurement probe, RS command, Bluetooth® request or press of a button.

The instrument can be switched off completely for a long period of non-use, but this will necessitate a zero reset on restart (the origin will be lost)

Prolonged press (>4s) on 



10. Re-initialising the instrument

The initial instrument settings can be restored at any time by a prolonged press (>4 sec) simultaneously on  and  until the message *reSet* is displayed.

Nevertheless the instrument retains its configuration settings (units and resolution).

11. Personalising the instrument

Access to the functions of your instrument can be personalised, for more information see manufacturer's website (requires you to connect your instrument via a Proximity RS/USB cable).

Possibilities:

- De-activate or active the required functions
- Modify access to the advanced functions (direct access)

12. Connecting the instrument

The instrument can be connected to a peripheral via a Proximity (RS or USB) or Bluetooth® Smart. (See chap. 1)

Measured values can be transmitted and the instrument driven using predefined retro-commands (see chap. 13 for a list of the main commands)

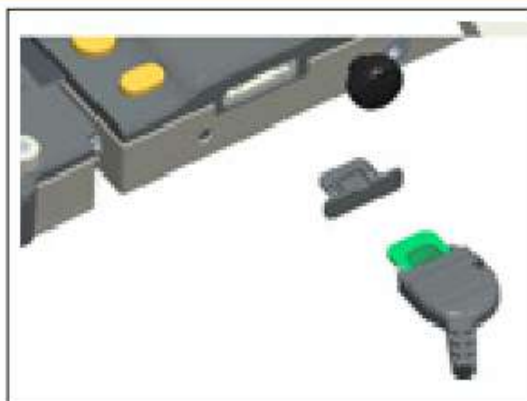

13. List of the main commands

Selection and configuration

CHA+ / CHA-	Change measurement direction
FCT0 ...9...A...F	Assign «favourite» function
MM / IN	Change measurement unit
KEY0 / KEY1	Lock / unlock keypad
MUL [+/-] xxx.xxxx	Modification of the multiplier
PRE [+/-] xxx.xxx	Modify preset value
REF1 / REF2 / AREF	Change the active reference
STO1 / STO0	Activate/de-activate HOLD
TOL1 / TOL0	Activate/de-activate tolerances
LCAL dd.mm.yy	Modify last calibration date
NCAL dd.mm.yy	Modify next calibration date
TOL +/-xxx.xxx +/-zzz.zzz	Inputting tolerance limits
MIN / MAX / DEL / NOR	Selecting MIN, MAX, Delta, Normal mode
CLE	Re-initialisation of MIN, MAX or Delta mode
UNI1 / UNI0	Activate/de-activate change of units
OUT1 / OUT0	Activate/de-activate contin. data transmission
PRE ON / PRE OFF	Activate/de-activate preset function
PRE	Recall preset
SET	Zero reset
NUM xxxxxxxxxx	Modify the serial number

Interrogation

?	Current value? (mode Tol, value followed by < >)
CHA?	Measurement sense?
FCT?	«Favorite» function active?
UNI?	Measurement unit active?
KEY?	Keypad locked?
MUL?	Multiplier value?
PRE?	Preset value?
REF?	Reference active?
STO?	Status of HOLD function?
TOL?	Current tolerance limit values?
LCAL?	Date of last calibration?
NCAL?	Date of next calibration?
MOD?	Active mode (MIN, MAX, Delta or Normal)?
SET?	Main instruments parameters?
ID?	Instrument identification code?
NUM?	Serial number?

Bluetooth®

BT0/BT1	Activate/de-activate Bluetooth® modules
BTRST	Reset pairing information
MAC?	Bluetooth® MAC adress ?

Maintenance functions

BAT?	Battery status (BAT1=Ok, BAT0=low battery)
OFF	Switch off (wake up using a button or RS)
RST	Re-initialisation of the instrument
SBY	Put instrument in stand-by(SIS)
VER?	Version No. and date of firmware

